



# Dell SP2318H/SP2418H Monitor

## User's Guide

**Model:** SP2318H/SP2418H  
**Regulatory model:** P2317Hb, P2417Hb



# Notes, cautions, and warnings

-  **NOTE:** A NOTE indicates important information that helps you make better use of your computer.
-  **CAUTION:** A CAUTION indicates potential damage to hardware or loss of data if instructions are not followed.
-  **WARNING:** A WARNING indicates a potential for property damage, personal injury, or death.

**Copyright © 2017 Dell Inc. All rights reserved.** This product is protected by U.S. and international copyright and intellectual property laws. Dell™ and the Dell logo are trademarks of Dell Inc. in the United States and/or other jurisdictions. All other marks and names mentioned herein may be trademarks of their respective companies.

2017 - 05

Rev. A00

# Contents

<b>About Your Monitor . . . . .</b>	<b>6</b>
<b>Package Contents . . . . .</b>	<b>6</b>
<b>Product Features . . . . .</b>	<b>8</b>
<b>Identifying Parts and Controls . . . . .</b>	<b>9</b>
<b>Front View . . . . .</b>	<b>9</b>
<b>Back View . . . . .</b>	<b>10</b>
<b>Side View . . . . .</b>	<b>11</b>
<b>Bottom View . . . . .</b>	<b>12</b>
<b>Monitor Specifications . . . . .</b>	<b>13</b>
<b>Resolution Specifications . . . . .</b>	<b>14</b>
<b>Supported Video Modes . . . . .</b>	<b>14</b>
<b>Preset Display Modes . . . . .</b>	<b>15</b>
<b>Electrical Specifications . . . . .</b>	<b>15</b>
<b>Physical Characteristics . . . . .</b>	<b>16</b>
<b>Environmental Characteristics . . . . .</b>	<b>17</b>
<b>Power Management Modes . . . . .</b>	<b>18</b>
<b>Pin Assignments . . . . .</b>	<b>20</b>
<b>Plug and Play Capability . . . . .</b>	<b>23</b>
<b>Universal Serial Bus (USB) Interface . . . . .</b>	<b>23</b>
<b>USB 3.0 Upstream Connector . . . . .</b>	<b>24</b>
<b>USB 3.0 Downstream Connector . . . . .</b>	<b>24</b>
<b>USB 2.0 Downstream Connector . . . . .</b>	<b>25</b>
<b>USB Ports . . . . .</b>	<b>25</b>
<b>LCD Monitor Quality and Pixel Policy . . . . .</b>	<b>26</b>
<b>Maintenance Guidelines . . . . .</b>	<b>26</b>
<b>Cleaning Your Monitor . . . . .</b>	<b>26</b>



<b>Setting Up the Monitor</b> . . . . .	<b>27</b>
Attaching the Stand . . . . .	27
Connecting Your Monitor . . . . .	29
Connecting the VGA cable . . . . .	29
Connecting the HDMI cable . . . . .	29
Connecting the DisplayPort (DP to DP) cable (optional) . . . . .	30
Connecting the USB 3.0 cable . . . . .	30
Organizing Your Cables . . . . .	31
Removing the Monitor Stand . . . . .	32
Wall Mounting (Optional) . . . . .	33
<b>Operating the Monitor</b> . . . . .	<b>34</b>
Power On the Monitor . . . . .	34
Using the Front-Panel Controls . . . . .	34
Front-Panel Button . . . . .	35
Using the On-Screen Display (OSD) Menu . . . . .	36
Accessing the Menu System . . . . .	36
OSD Warning Message . . . . .	49
Setting the Maximum Resolution . . . . .	51
Using the Tilt, Swivel, and Vertical Extension . . . . .	52
Tilt, Swivel . . . . .	52
Vertical Extension . . . . .	53
Rotating the Monitor . . . . .	53
Adjusting the Rotation Display Settings of Your System . . . . .	54
<b>Troubleshooting</b> . . . . .	<b>56</b>
Self-Test . . . . .	56
Built-in Diagnostics . . . . .	57
Common Problems . . . . .	58
Product Specific Problems . . . . .	62
Universal Serial Bus (USB) Specific Problems . . . . .	63





**Appendix . . . . . 65**  
    **FCC Notices (U.S. Only) and Other Regulatory**  
    **Information. . . . . 65**  
    **Contact Dell . . . . . 65**





# About Your Monitor



## Package Contents

Your monitor ships with the components shown in the table below. If any component is missing, contact Dell technical support. For more information, see [Contact Dell](#).

-  **NOTE: Some items may be optional and may not ship with your monitor. Some features or media may not be available in certain countries.**
-  **NOTE: To set up your monitor with a third-party stand, refer to the respective stand setup guide for setup instructions.**

	Monitor
	Stand Riser



	Stand Base
	Power Cable (Varies by Country)
	VGA Cable
	HDMI Cable
	USB 3.0 Upstream Cable (Enables the USB Ports on the Monitor)
	<ul style="list-style-type: none"> <li>• Drivers and Documentation Media</li> <li>• Quick Setup Guide</li> <li>• Safety, Environmental, and Regulatory Information</li> </ul>



## Product Features

The **Dell SP2318H/SP2418H** flat panel display has an active matrix, Thin-Film Transistor (TFT), Liquid Crystal Display (LCD) and LED backlight. The monitor features include:

- **SP2318H:** 58.4 cm (23-inch) viewable area (measured diagonally).  
Resolution: Up to 1920 x 1080 through VGA, DisplayPort, and HDMI, with full-screen support or lower resolutions.
- **SP2418H:** 60.5 cm (23.8-inch) viewable area (measured diagonally).  
Resolution: Up to 1920 x 1080 through VGA, DisplayPort, and HDMI, with full-screen support or lower resolutions.
- Color gamut of 72% NTSC.
- Tilt, swivel, height, and rotate adjustment capabilities.
- Removable stand and Video Electronics Standards Association (VESA™) 100 mm mounting holes for flexible mounting solutions.
- Digital connectivity with DisplayPort and HDMI.
- Equipped with 1 USB upstream port and 4 USB downstream ports.
- Plug and play capability if supported by your system.
- On-Screen Display (OSD) adjustments for ease of set-up and screen optimization.
- Software and documentation media includes an Information File (INF), Image Color Matching File (ICM), and product documentation.
- Security lock slot.
- Stand lock.
- 0.3 W standby power when in sleep mode.
- Energy Gauge shows the energy level being consumed by the monitor in real time.
- Optimize eye comfort with a flicker-free screen and ComfortView feature which minimizes blue light emission.





# Identifying Parts and Controls

## Front View

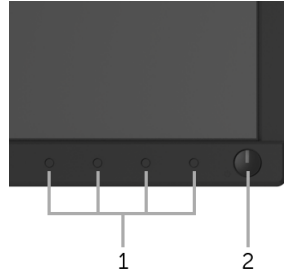

Front panel controls

Label	Description
1	Function buttons (For more information, see <a href="#">Operating the Monitor</a> )
2	Power On/Off button (with LED indicator)



## Back View



**Back view with monitor stand**

Label	Description	Use
1	VESA mounting holes (100 mm x 100 mm - behind attached VESA Cover)	Wall mount monitor using VESA-compatible wall mount kit (100 mm x 100 mm).
2	Regulatory label	Lists the regulatory approvals.
3	Stand release button	Releases stand from monitor.
4	Security lock slot	Secures monitor with security lock (security lock not included).
5	Barcode, serial number, and Service Tag label	Refer to this label if you need to contact Dell for technical support.
6	Dell Soundbar mounting slots	Attaches the optional Dell Soundbar. <b>NOTE:</b> Please remove the plastic strip covering the mounting slots before affixing the Dell Soundbar.
7	Cable-management slot	Use to organize cables by placing them through the slot.



## Side View

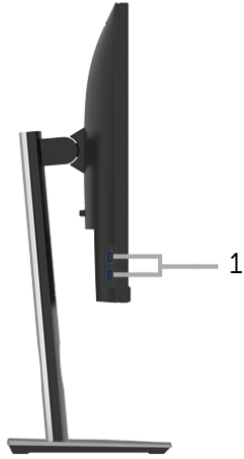

Label	Description	Use
1	USB downstream port	Connect your USB device. <b>NOTE:</b> To use this port, you must connect the USB cable (shipped with your monitor) to the USB-upstream port on the monitor and to your computer.



## Bottom View

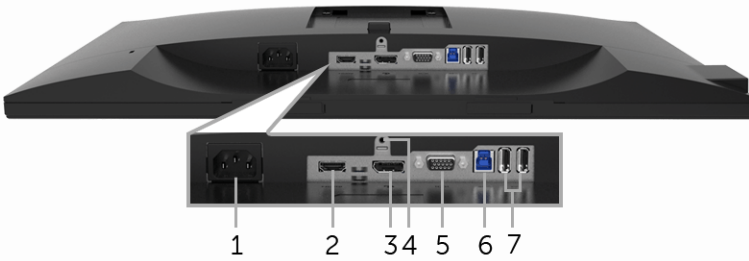

**Bottom view without monitor stand**

Label	Description	Use
1	Power cable connector	Connect the power cable.
2	HDMI port	Connect your computer with HDMI cable.
3	DisplayPort	Connect your computer with DP cable. (cable not included)
4	Stand lock feature	To lock the stand to the monitor using a M3 x 6 mm screw (screw not included).
5	VGA connector	Connect your computer with VGA cable.
6	USB upstream port	Connect the USB cable (shipped with your monitor) to this port and your computer to enable the USB ports on your monitor.
7	USB downstream port	Connect USB device. <b>NOTE:</b> To use this port, you must connect the USB cable (shipped with your monitor) to the USB-upstream port on the monitor and to your computer.



## Monitor Specifications

Model	SP2318H	SP2418H
Screen type	Active matrix - TFT LCD	
Panel technology	In-Plane Switching Technology	
Aspect ratio	16:9	
Viewable image		
Diagonal	584.20 mm (23 inches)	604.52 mm (23.8 inches)
Horizontal, Active Area	509.18 mm (20.05 inches)	527.04 mm (20.75 inches)
Vertical, Active Area	286.42 mm (11.28 inches)	296.46 mm (11.67 inches)
Area	145839.33 mm <sup>2</sup> (226.05 inch <sup>2</sup> )	156246.27 mm <sup>2</sup> (242.18 inch <sup>2</sup> )
Pixel pitch	0.265 mm x 0.265 mm	0.275 mm x 0.275 mm
Pixel per inch (PPI)	96	93
Viewing angle	178° (vertical) typical 178° (horizontal) typical	
Brightness	250 cd/m <sup>2</sup> (typical)	
Contrast ratio	1000 to 1 (typical) 4 Million: 1 (Dynamic)	
Display screen coating	Anti-Glare with 3H hardness	
Backlight	White LED edgelight system	
Response time (typical)	6 ms (gray to gray)	
Color depth	16.7 million colors	
Color gamut	82% NTSC (CIE1976)*	
Built-in devices	<ul style="list-style-type: none"> <li>• USB 3.0 super-speed hub (with 1 x USB 3.0 upstream port)</li> <li>• 2 x USB 3.0 downstream ports</li> <li>• 2 x USB 2.0 downstream ports</li> </ul>	



Connectivity	<ul style="list-style-type: none"> <li>• 1 x DP 1.2</li> <li>• 1 x HDMI 1.4</li> <li>• 1 x VGA</li> <li>• 1 x USB 3.0 port - Upstream</li> <li>• 2 x USB 3.0 port - Side</li> <li>• 2 x USB 2.0 port - Bottom</li> </ul>
Border width (edge of monitor to active area)	11.4 mm (Top/Left/Right) 18.1 mm (Bottom)
Adjustability	
Height adjustable stand	130 mm
Tilt	-5° to 21°
Swivel	-45° to 45°
Pivot	90° (clockwise)
Dell Display Manager Compatibility	Yes
Security	Security lock slot (cable lock sold separately)

\* Color gamut (typical) is based on CIE1976 (82% NTSC) and CIE1931 (72% NTSC) test standards.

## Resolution Specifications

Model	SP2318H/SP2418H
Horizontal scan range	30 kHz to 83 kHz (automatic)
Vertical scan range	56 Hz to 76 Hz (automatic)
Maximum preset resolution	1920 x 1080 at 60 Hz

## Supported Video Modes

Model	SP2318H/SP2418H
Video display capabilities (VGA, HDMI & DP playback)	480i, 480p, 576i, 576p, 720p, 1080i, 1080p



## Preset Display Modes

Display Mode	Horizontal Frequency (kHz)	Vertical Frequency (Hz)	Pixel Clock (MHz)	Sync Polarity (Horizontal/Vertical)
VESA, 640 x 480	31.5	60.0	25.2	-/-
VESA, 640 x 480	37.5	75.0	31.5	-/-
IBM, 720 x 400	31.5	70.0	28.3	-/+
VESA, 800 x 600	37.9	60.0	40.0	+/+
VESA, 800 x 600	46.9	75.0	49.5	+/+
VESA, 1024 x 768	48.4	60.0	65.0	-/-
VESA, 1024 x 768	60.0	75.0	78.8	+/+
VESA, 1152 x 864	67.5	75.0	108.0	+/+
VESA, 1280 x 1024	64.0	60.0	108.0	+/+
VESA, 1280 x 1024	80.0	75.0	135.0	+/+
VESA, 1600 x 900	60.0	60.0	108.0	+/+
VESA, 1920 x 1080	67.5	60.0	148.5	+/+

## Electrical Specifications

Model	SP2318H/SP2418H
Video input signals	<ul style="list-style-type: none"> <li>• Analog RGB, 0.7 Volts +/- 5%, positive polarity at 75 ohm input impedance</li> <li>• HDMI 1.4, 600 mV for each differential line, 100 ohm input impedance per differential pair</li> <li>• DisplayPort 1.2, 600 mV for each differential line, 100 ohm input impedance per differential pair</li> </ul>
AC input voltage/frequency/current	100 VAC to 240 VAC / 50 Hz or 60 Hz $\pm$ 3 Hz / 1.5 A (typical)
Inrush current	<ul style="list-style-type: none"> <li>• 120 V: 30 A (Max.) at 0 °C (cold start)</li> <li>• 220 V: 60 A (Max.) at 0 °C (cold start)</li> </ul>



## Physical Characteristics

Model	SP2318H	SP2418H
<b>Signal cable type</b>	<ul style="list-style-type: none"> <li>• Analog: D-Sub, 15 pins</li> <li>• Digital: DisplayPort, 20 pins (cable not included)</li> <li>• Digital: HDMI, 19 pins</li> <li>• Universal Serial Bus: USB, 9 pins</li> </ul>	
<b>Dimensions (with stand)</b>		
Height (extended)	487.1 mm (19.17 inches)	492.1 mm (19.37 inches)
Height (compressed)	357.1 mm (14.06 inches)	362.1 mm (14.26 inches)
Width	532.0 mm (20.94 inches)	549.8 mm (21.65 inches)
Depth	180.0 mm (7.09 inches)	180.0 mm (7.09 inches)
<b>Dimensions (without stand)</b>		
Height	315.9 mm (12.43 inches)	326.0 mm (12.83 inches)
Width	532.0 mm (20.94 inches)	549.8 mm (21.65 inches)
Depth	50.3 mm (1.98 inches)	50.3 mm (1.98 inches)
<b>Stand dimensions</b>		
Height (extended)	400.8 mm (15.78 inches)	400.8 mm (15.78 inches)
Height (compressed)	354.4 mm (13.95 inches)	354.4 mm (13.95 inches)
Width	242.6 mm (9.55 inches)	242.6 mm (9.55 inches)
Depth	180.0 mm (7.09 inches)	180.0 mm (7.09 inches)
<b>Weight</b>		
Weight with packaging	7.34 kg (16.18 lb)	7.63 kg (16.78 lb)
Weight with stand assembly and cables	5.59 kg (12.32 lb)	5.90 kg (12.98 lb)
Weight without stand assembly (For wall mount or VESA mount considerations - no cables)	3.06 kg (6.75 lb)	3.33 kg (7.32 lb)





Weight of stand assembly	2.10 kg (4.63 lb)	2.10 kg (4.63 lb)
Front frame gloss	2-4	2-4

## Environmental Characteristics

Model	SP2318H	SP2418H
<b>Compliant Standards</b>		
<ul style="list-style-type: none"> <li>ENERGY STAR certified Monitor</li> <li>EPEAT Gold registered in the U.S. EPEAT registration varies by country. See <a href="http://www.epeat.net">www.epeat.net</a> for registration status by country</li> <li>RoHS-compliant</li> <li>BFR/PVC Free monitor (excluding external cables)</li> <li>Arsenic-Free glass and Mercury-Free for the panel only</li> </ul>		
<b>Temperature</b>		
Operating	0 °C to 40 °C (32 °F to 104 °F)	
Non-operating	<ul style="list-style-type: none"> <li>Storage: -20 °C to 60 °C (-4 °F to 140 °F)</li> <li>Shipping: -20 °C to 60 °C (-4 °F to 140 °F)</li> </ul>	
<b>Humidity</b>		
Operating	10% to 80% (non-condensing)	
Non-operating	<ul style="list-style-type: none"> <li>Storage: 5% to 90% (non-condensing)</li> <li>Shipping: 5% to 90% (non-condensing)</li> </ul>	
<b>Altitude</b>		
Operating	5,000 m (16,404 ft) (maximum)	
Non-operating	12,192 m (40,000 ft) (maximum)	
<b>Thermal dissipation</b>	<ul style="list-style-type: none"> <li>129.66 BTU/hour (maximum)</li> <li>61.42 BTU/hour (typical)</li> </ul>	<ul style="list-style-type: none"> <li>133.07 BTU/hour (maximum)</li> <li>64.83 BTU/hour (typical)</li> </ul>



## Power Management Modes

If you have VESA's DPM™ compliance display card or software installed in your PC, the monitor can automatically reduce its power consumption when not in use. This feature is called *Power Save Mode\**. If the computer detects input from the keyboard, mouse, or other input devices, the monitor automatically resumes functioning. The following table shows the power consumption and signaling of this automatic power saving feature.

### SP2318H

VESA Modes	Horizontal Sync	Vertical Sync	Video	Power Indicator	Power Consumption
Normal operation	Active	Active	Active	White	38 W (maximum)** 18 W (typical)
Active-off mode	Inactive	Inactive	Blanked	White (blinking)	Less than 0.3 W
Switch off	-	-	-	Off	Less than 0.3 W

Energy Star	Power Consumption
P <sub>on</sub>	14.8 W
E <sub>TEC</sub>	46.7 kWh

### SP2418H

VESA Modes	Horizontal Sync	Vertical Sync	Video	Power Indicator	Power Consumption
Normal operation	Active	Active	Active	White	39 W (maximum)** 19 W (typical)
Active-off mode	Inactive	Inactive	Blanked	White (blinking)	Less than 0.3 W
Switch off	-	-	-	Off	Less than 0.3 W



Energy Star	Power Consumption
$P_{on}$	18.5 W
$E_{TEC}$	54.1 kWh

The OSD functions only in the normal operation mode. When any button is pressed in the Active-off mode, the following message will be displayed:

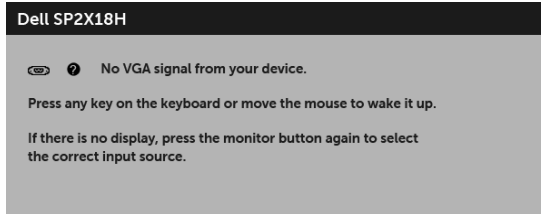

Activate the computer and the monitor to gain access to the OSD.

 **NOTE: The message may be slightly different according to the connected input signal.**

 **NOTE: This monitor is ENERGY STAR®-compliant.**



 **NOTE:**

**$P_{on}$ : Power consumption of on mode as defined in Energy Star 7.0 version.**

**$E_{TEC}$ : Total energy consumption in kWh as defined in Energy Star 7.0 version.**

\* Zero power consumption in OFF mode can only be achieved by disconnecting the main cable from the monitor.

\*\* Maximum power consumption with max luminance, and USB active.

This document is informational only and reflects laboratory performance. Your product may perform differently, depending on the software, components and peripherals you ordered and shall have no obligation to update such information. Accordingly, the customer should not rely upon this information in making decisions about electrical tolerances or otherwise. No warranty as to accuracy or completeness is expressed or implied.



## Pin Assignments

### VGA Connector

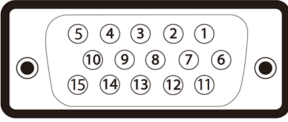

Pin Number	15-pin Side of the Connected Signal Cable
1	Video-Red
2	Video-Green
3	Video-Blue
4	GND
5	Self-test
6	GND-R
7	GND-G
8	GND-B
9	Computer 5 V/3.3 V
10	GND-sync
11	GND
12	DDC data
13	H-sync
14	V-sync
15	DDC clock



## DisplayPort Connector

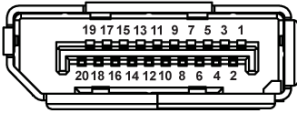

Pin Number	20-pin Side of the Connected Signal Cable
1	ML0(p)
2	GND
3	ML0(n)
4	ML1(p)
5	GND
6	ML1(n)
7	ML2(p)
8	GND
9	ML2(n)
10	ML3(p)
11	GND
12	ML3(n)
13	GND
14	GND
15	AUX(p)
16	GND
17	AUX(n)
18	GND
19	Re-PWR
20	+3.3 V DP_PWR



## HDMI Connector

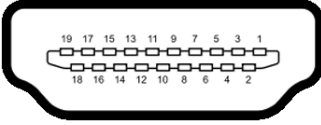

Pin Number	19-pin Side of the Connected Signal Cable
1	TMDS DATA 2+
2	TMDS DATA 2 SHIELD
3	TMDS DATA 2-
4	TMDS DATA 1+
5	TMDS DATA 1 SHIELD
6	TMDS DATA 1-
7	TMDS DATA 0+
8	TMDS DATA 0 SHIELD
9	TMDS DATA 0-
10	TMDS CLOCK+
11	TMDS CLOCK SHIELD
12	TMDS CLOCK-
13	CEC
14	Reserved (N.C. on device)
15	DDC CLOCK (SCL)
16	DDC DATA (SDA)
17	DDC/CEC Ground
18	+5V POWER
19	HOT PLUG DETECT



## Plug and Play Capability

You can install the monitor in any Plug and Play-compatible system. The monitor automatically provides the computer system with its Extended Display Identification Data (EDID) using Display Data Channel (DDC) protocols so that the system can configure itself and optimize the monitor settings. Most monitor installations are automatic; you can select different settings if desired. For more information about changing the monitor settings, see [Operating the Monitor](#).

## Universal Serial Bus (USB) Interface

This section gives you information about the USB ports that are available on the monitor.

 **NOTE: This monitor is Super-Speed USB 3.0 and High-Speed USB 2.0 compatible.**

Transfer Speed	Data Rate	Power Consumption
Super-speed	5 Gbps	4.5 W (Max, each port)
High speed	480 Mbps	4.5 W (Max, each port)
Full speed	12 Mbps	4.5 W (Max, each port)

Transfer Speed	Data Rate	Power Consumption
High speed	480 Mbps	2.5 W (Max, each port)
Full speed	12 Mbps	2.5 W (Max, each port)
Low speed	1.5 Mbps	2.5 W (Max, each port)



## USB 3.0 Upstream Connector

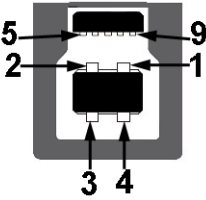

Pin Number	9-pin Side of the Connector
1	VCC
2	D-
3	D+
4	GND
5	SSTX-
6	SSTX+
7	GND
8	SSRX-
9	SSRX+

## USB 3.0 Downstream Connector



Pin Number	9-pin Side of the Connector
1	VCC
2	D-
3	D+
4	GND





<b>5</b>	SSRX-
<b>6</b>	SSRX+
<b>7</b>	GND
<b>8</b>	SSTX-
<b>9</b>	SSTX+

### USB 2.0 Downstream Connector

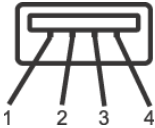

<b>Pin Number</b>	<b>4-pin Side of the Connector</b>
<b>1</b>	VCC
<b>2</b>	DMD
<b>3</b>	DPD
<b>4</b>	GND

### USB Ports

- 1 x USB 3.0 upstream - bottom
- 2 x USB 2.0 downstream - bottom
- 2 x USB 3.0 downstream - side

 **NOTE: USB 3.0 functionality requires a USB 3.0-capable computer.**

 **NOTE: The monitor's USB interface works only when the monitor is On or in the power save mode. If you turn Off the monitor and then turn it On, the attached peripherals may take a few seconds to resume normal functionality.**



## LCD Monitor Quality and Pixel Policy

During the LCD Monitor manufacturing process, it is not uncommon for one or more pixels to become fixed in an unchanging state which are hard to see and do not affect the display quality or usability. For more information on Dell Monitor Quality and Pixel Policy, see Dell Support site at: <http://www.dell.com/support/monitors>.

## Maintenance Guidelines

### Cleaning Your Monitor

 **CAUTION:** Read and follow the [Safety Instructions](#) before cleaning the monitor.

 **WARNING:** Before cleaning the monitor, unplug the monitor power cable from the electrical outlet.

For best practices, follow the instructions in the list below while unpacking, cleaning, or handling your monitor:

- To clean your anti-static screen, lightly dampen a soft, clean cloth with water. If possible, use a special screen-cleaning tissue or solution suitable for the anti-static coating. Do not use benzene, thinner, ammonia, abrasive cleaners, or compressed air.
- Use a lightly-dampened, warm cloth to clean the monitor. Avoid using detergent of any kind as some detergents leave a milky film on the monitor.
- If you notice white powder when you unpack your monitor, wipe it off with a cloth.
- Handle your monitor with care as a darker-colored monitor may get scratched and show white scuff marks more than a lighter-colored monitor.
- To help maintain the best image quality on your monitor, use a dynamically changing screen saver and turn Off your monitor when not in use.



# Setting Up the Monitor

## Attaching the Stand

 **NOTE:** The stand is detached when the monitor is shipped from the factory.

 **NOTE:** This is applicable for a monitor with a stand. If you have purchased a third-party stand, refer to the respective stand setup guide for the set-up instructions.

To attach the monitor stand:

1. Follow the instructions on the flaps of carton to remove the stand from the top cushion that secures it.
2. Insert the stand base blocks fully into the stand slot.
3. Lift the screw handle and turn the screw clockwise.
4. After fully tightening the screw, fold the screw handle flat within the recess.

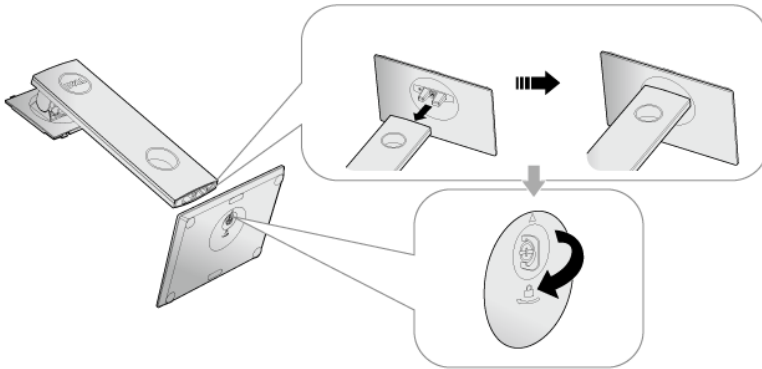

5. Lift the cover, as shown, to expose the VESA area for stand assembly.

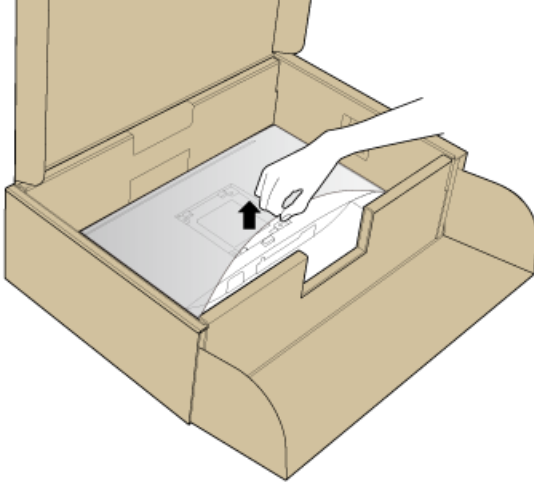

6. Attach the stand assembly to the monitor.

- a. Fit the two tabs on the upper part of the stand to the groove on the back of the monitor.
- b. Press the stand down till it snaps into place.

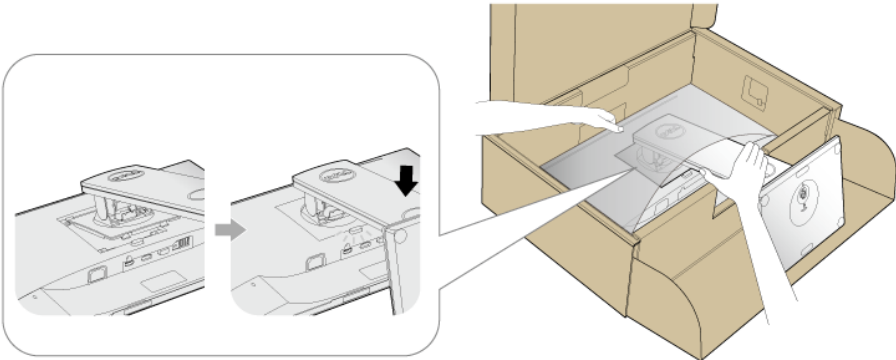

7. Place the monitor upright.

**NOTE:** Lift the monitor carefully to prevent it from slipping or falling.



## Connecting Your Monitor

**⚠ WARNING:** Before you begin any of the procedures in this section, follow the [Safety Instructions](#).

**✍ NOTE:** Route the cables through the cable-management slot before connecting them.

**✍ NOTE:** Do not connect all cables to the computer at the same time.

To connect your monitor to the computer:

1. Turn Off your computer and disconnect the power cable.
2. Connect the VGA, DP or HDMI cable from your monitor to the computer.

### Connecting the VGA cable

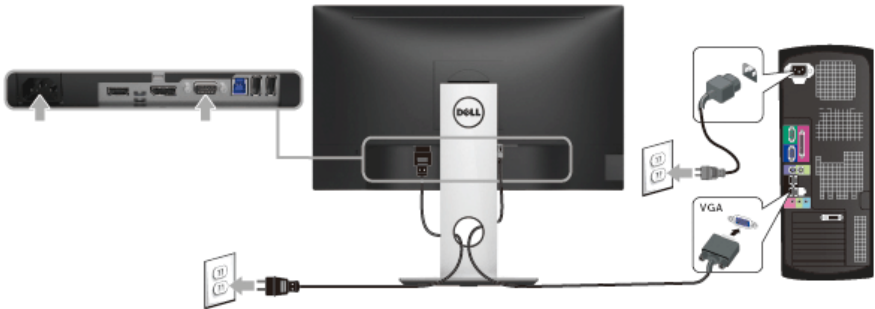

### Connecting the HDMI cable



## Connecting the DisplayPort (DP to DP) cable (optional)

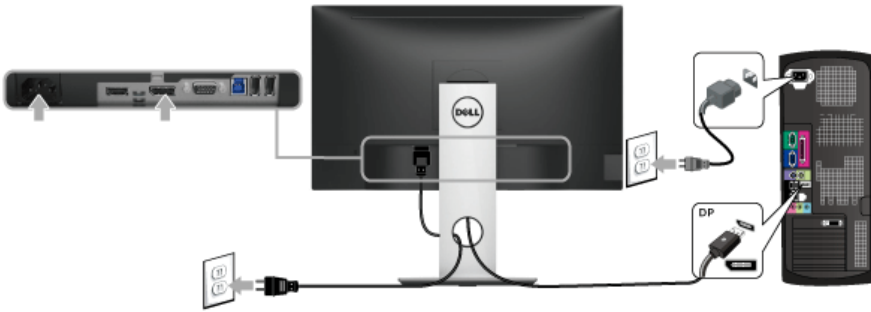

**NOTE:** The graphics are used for the purpose of illustration only. Appearance of the computer may vary.

## Connecting the USB 3.0 cable

After you have completed connecting the VGA/DP/HDMI cable, follow the procedures below to connect the USB 3.0 cable to the computer and complete your monitor setup:

1. Connect the upstream USB 3.0 port (cable supplied) to an appropriate USB 3.0 port on your computer. (See [Bottom View](#) for details.)
2. Connect the USB 3.0 peripherals to the downstream USB 3.0 ports on the monitor.
3. Plug the power cables for your computer and monitor into a nearby outlet.
4. Turn On the monitor and the computer.  
If your monitor displays an image, installation is complete. If it does not display an image, see [Universal Serial Bus \(USB\) Specific Problems](#).



5. Use the cable slot on the monitor stand to organize the cables.

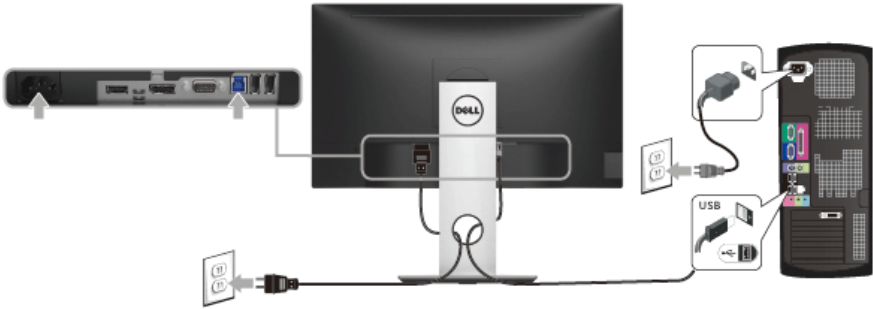

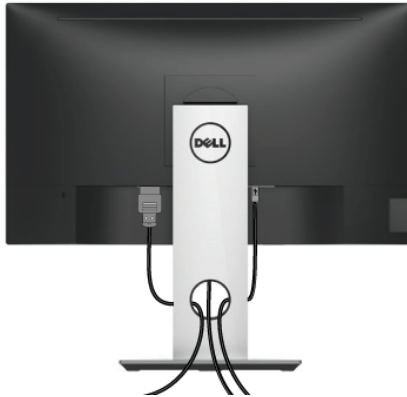

## Organizing Your Cables



After attaching all necessary cables to your monitor and computer, (See [Connecting Your Monitor](#) for cable attachment,) organize all cables as shown above.



## Removing the Monitor Stand

-  **NOTE:** To prevent scratches on the LCD screen while removing the stand, ensure that the monitor is placed on a soft, clean surface.
-  **NOTE:** This is applicable for a monitor with a stand. When any other stand is bought, please refer to the respective stand setup guide for the set-up instructions.

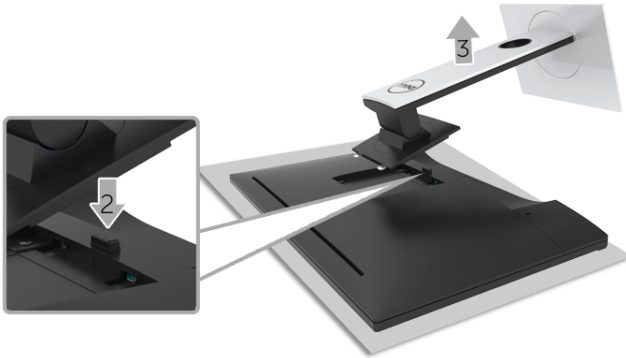

To remove the stand:

1. Place the monitor on a soft cloth or cushion.
2. Press and hold the stand release button.
3. Lift the stand up and away from the monitor.





## Wall Mounting (Optional)

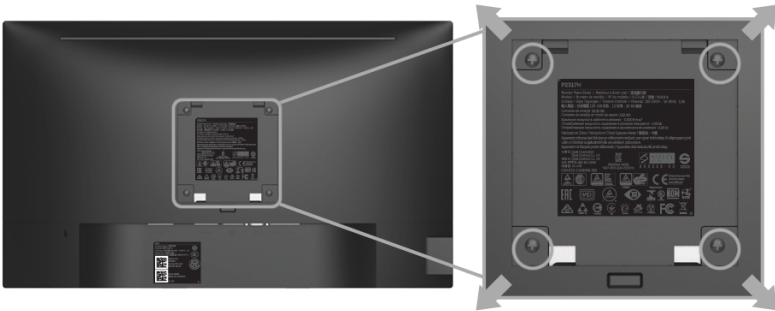

(Screw dimension: M4 x 10 mm).

Refer to the instructions that come with the VESA-compatible wall mounting kit.

1. Place the monitor panel on a soft cloth or cushion on a stable, flat table.
2. Remove the stand.
3. Use a Phillips crosshead screwdriver to remove the four screws securing the plastic cover.
4. Attach the mounting bracket from the wall mounting kit to the monitor.
5. Mount the monitor on the wall by following the instructions that comes with the wall mounting kit.

**NOTE:** For use only with UL-listed wall mount bracket with minimum weight/load bearing capacity of 3.06 kg (SP2318H) / 3.33 kg (SP2418H).



# Operating the Monitor

## Power On the Monitor

Press the  button to turn On the monitor.

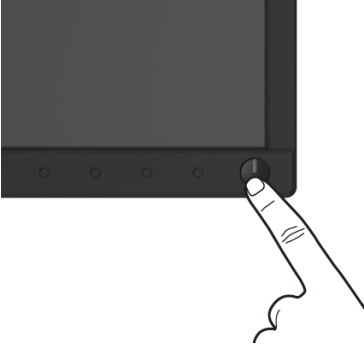

## Using the Front-Panel Controls



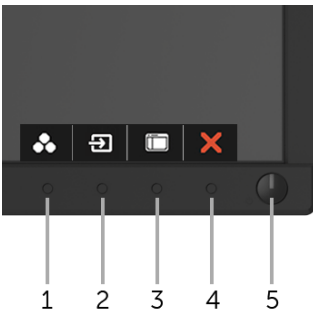

Use the control buttons on the front of the monitor to adjust the characteristics of the image being displayed. As you use these buttons to adjust the controls, an OSD shows the numeric values of the characteristics as they change.



The following table describes the front-panel buttons:

Front-Panel Button	Description
1  <b>Shortcut key/ Preset Modes</b>	Use this button to choose from a list of preset color modes.





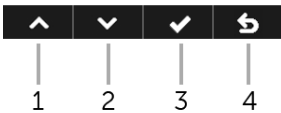

2	 <b>Shortcut key/ Input Source</b>	Use this button to choose from a list of video signals that may be connected to your monitor.
3	 <b>Menu</b>	Use the <b>MENU</b> button to launch the On-Screen Display (OSD) and select the OSD Menu. See <a href="#">Accessing the Menu System</a> .
4	 <b>Exit</b>	Use this button to go back to the main menu or exit the OSD main menu.
5	 <b>Power (with power light indicator)</b>	Use the <b>Power</b> button to turn the monitor <b>On</b> and <b>Off</b> . The white light indicates the monitor is <b>On</b> and fully functional. A blinking white light indicates the power save mode.

### Front-Panel Button

Use the buttons on the front of the monitor to adjust the image settings.





Front-Panel Button	Description
1  <b>Up</b>	Use the <b>Up</b> button to adjust (increase ranges) items in the OSD menu.
2  <b>Down</b>	Use the <b>Down</b> button to adjust (decrease ranges) items in the OSD menu.
3  <b>OK</b>	Use the <b>OK</b> button to confirm your selection in the OSD menu.
4  <b>Back</b>	Use the <b>Back</b> button to go back to the previous menu.



# Using the On-Screen Display (OSD) Menu

## Accessing the Menu System

 **NOTE:** If you change the settings and then either proceed to another menu or exit the OSD menu, the monitor automatically saves those changes. The changes are also saved if you change the settings and then wait for the OSD menu to disappear.

1. Press the  button to launch the OSD menu and display the main menu.

## Main Menu for analog (VGA) input

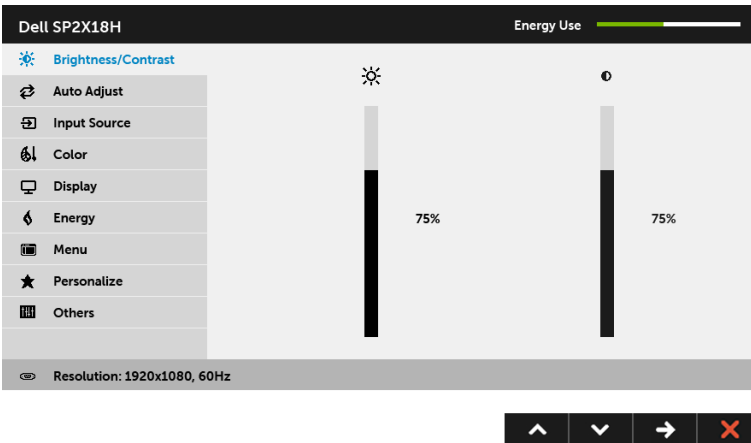

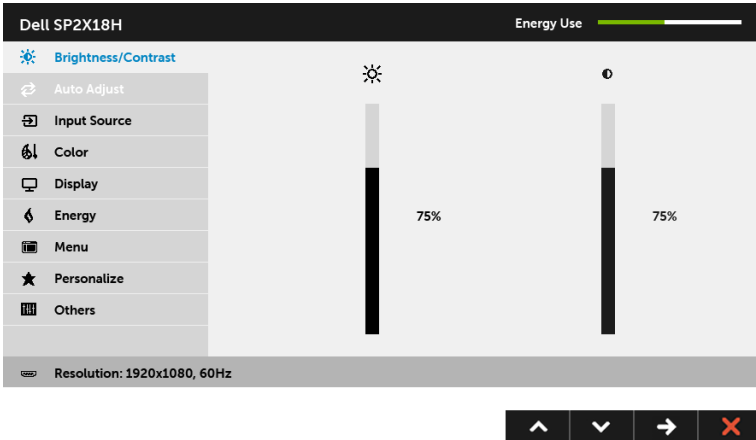

## Main Menu for digital (HDMI) input



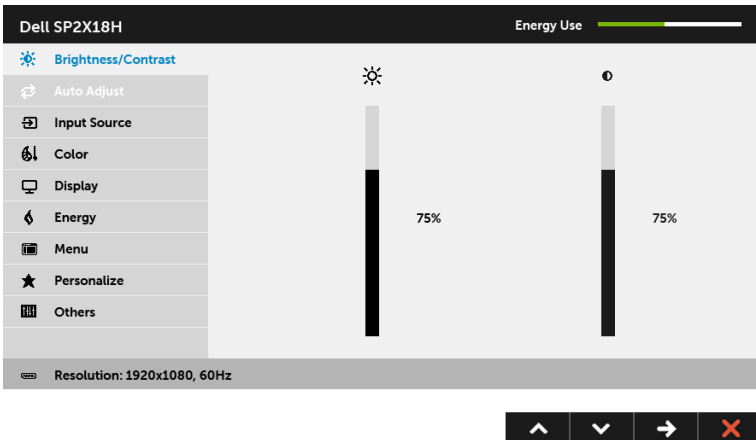





## Main Menu for digital (DP) input



 **NOTE:** Auto Adjust is only available when you use the analog (VGA) connector.



2. Press the  and  buttons to move between the setting options. As you move from one icon to another, the option name is highlighted. See the following table for a complete list of all the options available for the monitor.
3. Press the  button once to activate the highlighted option.

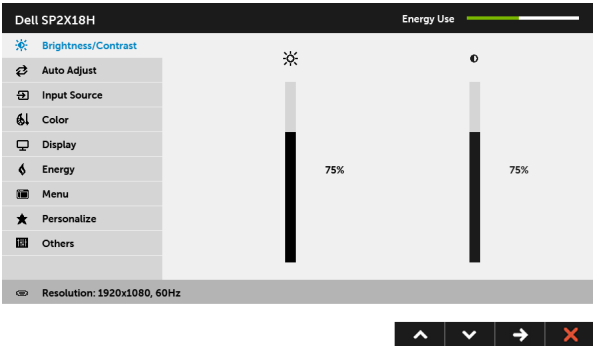

4. Press the  and  buttons to select the desired parameter.
5. Press  to enter the slide bar and then use the  and  buttons, according to the indicators on the menu, to make your changes.
6. Select the  button to return to the main menu.



Icon	Menu and Submenus	Description
	<b>Brightness/Contrast</b>	Use this menu to activate <b>Brightness/Contrast</b> adjustment.
		

**Brightness** **Brightness** adjusts the luminance of the backlight.

Press the  button to increase the brightness and press the  button to decrease the brightness (min. 0 / max. 100).

**NOTE:** Manual adjustment of **Brightness** is disabled when **Dynamic Contrast** is switched On.

**Contrast** Adjust the **Brightness** first, and then adjust the **Contrast** only if further adjustment is necessary.

Press the  button to increase the contrast and press the  button to decrease the contrast (min. 0 / max. 100).

The **Contrast** function adjusts the degree of difference between darkness and lightness on the monitor screen.





## Auto Adjust

Even though your computer recognizes your monitor on startup, the **Auto Adjust** function optimizes the display settings for use with your particular setup.

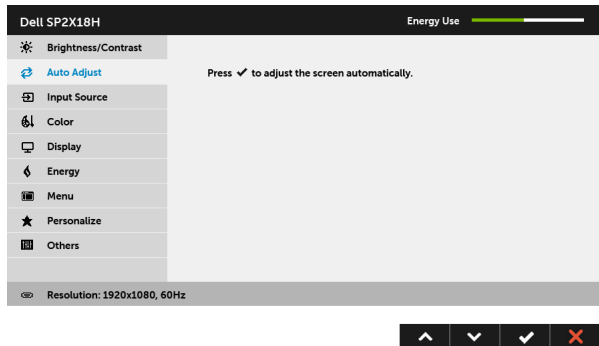

**Auto Adjust** allows the monitor to self-adjust to the incoming video signal. After using **Auto Adjust**, you can further tune your monitor by using the **Pixel Clock** (Coarse) and **Phase** (Fine) controls under **Display** settings.

Auto Adjustment in Progress...

**NOTE:** In most cases, **Auto Adjust** produces the best image for your configuration.

**NOTE:** **Auto Adjust** option is only available when you are using the analog (VGA) connector.





**Input Source** Use the **Input Source** menu to select between the different video signals that may be connected to your monitor.

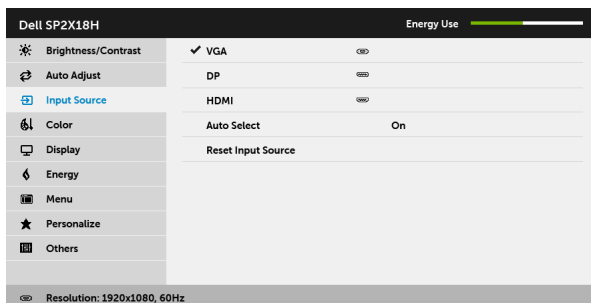

**VGA** Select the **VGA** input when you are using the analog (VGA) connector. Press to select the VGA input source.

**DP** Select the **DP** input when you are using the DisplayPort (DP) connector. Press to select the DisplayPort input source.

**HDMI** Select the **HDMI** input when you are using the HDMI connector. Press to select the HDMI input source.

**Auto Select** Turning on the function allows you to scan for available input sources.

**Reset Input Source** Reset your monitor input settings to the factory settings.







## Color

Use **Color** to adjust the color setting mode.

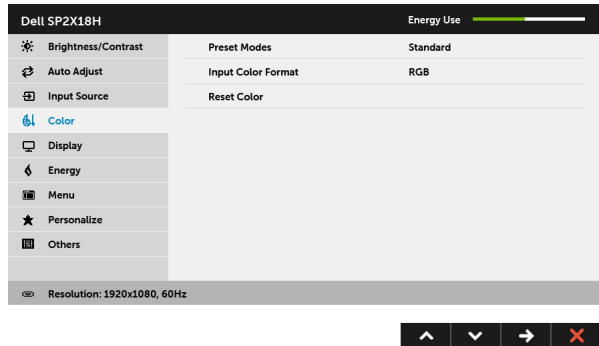



### Preset Modes

When you select **Preset Modes**, you can choose **Standard**, **ComfortView**, **Multimedia**, **Movie**, **Game**, **Warm**, **Cool**, or **Custom Color** from the list.

- **Standard**: Loads the monitor's default color settings. This is the default preset mode.
- **ComfortView**: Decreases the level of blue light emitted from the screen to make viewing more comfortable for your eyes.
- **Multimedia**: Loads color settings ideal for multimedia applications.
- **Movie**: Loads color settings ideal for movies.
- **Game**: Loads color settings ideal for most gaming applications.
- **Warm**: Increases the color temperature. The screen appears warmer with a red/yellow tint.
- **Cool**: Decreases the color temperature. The screen appears cooler with a blue tint.
- **Custom Color**: Allows you to manually adjust the color settings.



Use the  and  buttons to adjust the three colors (R, G, B) values and create your own preset color mode.

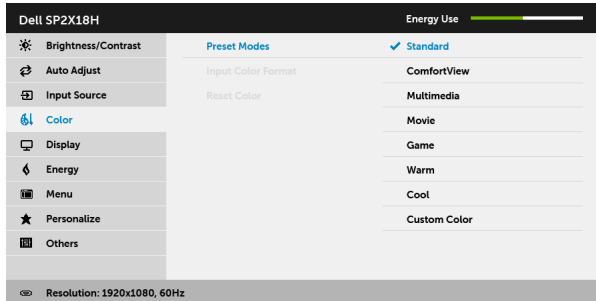

## Input Color Format

Allows you to set the video input mode to:

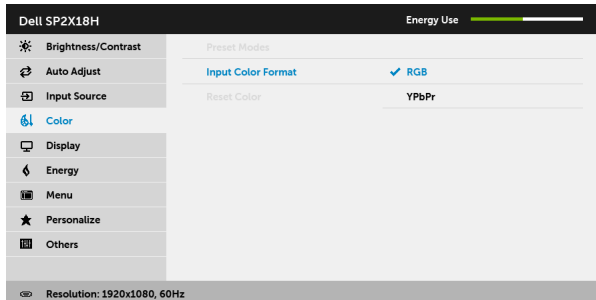

**RGB:** Select this option if your monitor is connected to a computer (or DVD player) using the DP or HDMI cable.

**YPbPr:** Select this option if your DVD player supports only YPbPr output.



---

## Hue

This feature can shift the color of the video image to green or purple. This is used to adjust the desired flesh tone color. Use  or  to adjust the hue from '0' to '100'.



Use  to increase the green shade of the video image.

Use  to increase the purple shade of the video image.

**NOTE: Hue** adjustment is available only when you select **Movie** or **Game** preset mode.

---

## Saturation

This feature can adjust the color saturation of the video image. Use  or  to adjust the saturation from '0' to '100'.

Use  to increase the colorful appearance of the video image.

Use  to increase the monochrome appearance of the video image.

**NOTE: Saturation** adjustment is available only when you select **Movie** or **Game** preset mode.

---

## Reset Color







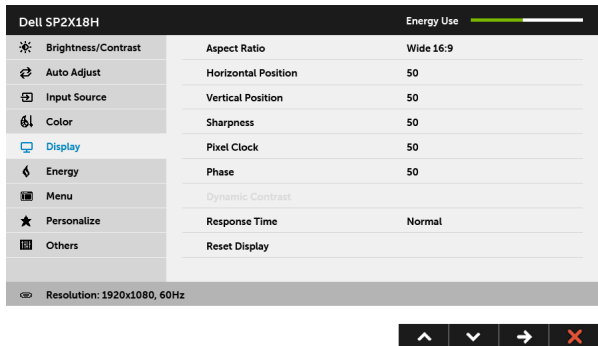

Reset your monitor color settings to the factory settings.



## Display

Use **Display** to adjust image.



<b>Aspect Ratio</b>	Adjusts the image ratio to <b>Wide 16:9</b> , <b>4:3</b> , or <b>5:4</b> .
<b>Horizontal Position</b>	Use  or  to adjust the image left or right. Minimum is '0' (-). Maximum is '100' (+).
<b>Vertical Position</b>	Use  or  to adjust the image up or down. Minimum is '0' (-). Maximum is '100' (+). <b>NOTE: Horizontal Position</b> and <b>Vertical Position</b> adjustments are only available for "VGA" input.
<b>Sharpness</b>	This feature can make the image look sharper or softer.  Use  or  to adjust the sharpness from '0' to '100'.
<b>Pixel Clock</b>	The <b>Phase</b> and <b>Pixel Clock</b> adjustments allow you to adjust your monitor to your preference.  Use  or  to adjust for best image quality.
<b>Phase</b>	If satisfactory results are not obtained using the <b>Phase</b> adjustment, use the <b>Pixel Clock</b> (coarse) adjustment and then use <b>Phase</b> (fine), again. <b>NOTE: Pixel Clock</b> and <b>Phase</b> adjustments are only available for "VGA" input.
<b>Dynamic Contrast</b>	Allows you to increase the level of contrast to provide sharper and more detailed image quality.  Use the  button to turn the <b>Dynamic Contrast</b> on or off. <b>NOTE: Dynamic Contrast</b> provides higher contrast if you select <b>Game</b> or <b>Movie</b> preset mode.
<b>Response Time</b>	Allows you to set the <b>Response Time</b> to <b>Normal</b> or <b>Fast</b> .
<b>Reset Display</b>	Select this option to restore default display settings.





## Energy

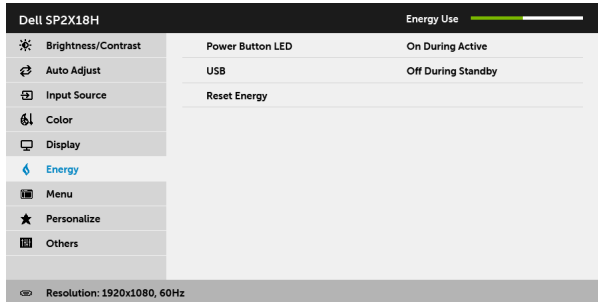

### Power Button LED

Allows you to set the power LED indicator On or Off to save energy.

### USB

Allows you to enable or disable USB function during monitor standby mode.

**NOTE:** USB ON/OFF under standby mode is only available when the USB upstream cable is unplugged. This option will be greyed out when the USB upstream cable plugs in.

### Reset Energy





Select this option to restore default **Energy** settings.

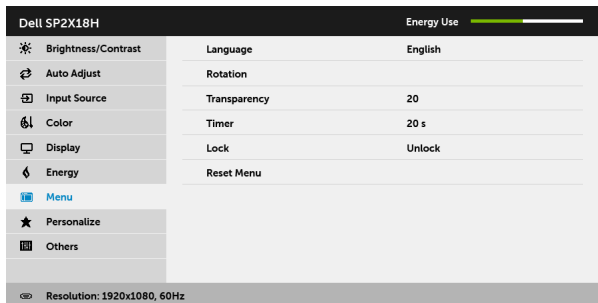

### Menu

Select this option to adjust the settings of the OSD, such as, the languages of the OSD, the amount of time the menu remains on screen, and so on.



<b>Language</b>	<b>Language</b> options set the OSD display to one of the eight languages (English, Spanish, French, German, Brazilian Portuguese, Russian, Simplified Chinese, or Japanese).
<b>Rotation</b>	Rotates the OSD by 90 degrees counter-clockwise. You can adjust the menu according to your <b>Display Rotation</b> .
<b>Transparency</b>	Select this option to change the menu transparency by pressing the  and  buttons (min. 0 / max. 100).
<b>Timer</b>	Allows you to set the time for which the OSD remains active after you press a button on the monitor.  Use  or  to adjust the slider in 1 second increments, from 5 to 60 seconds.
<b>Lock</b>	Controls user access to adjustments. When <b>Lock</b> is selected, no user adjustments are allowed. All buttons are locked.  <b>NOTE:</b> <b>Unlock</b> function– Only hard unlock (press and hold the button beside the power button for 6 seconds). <b>Lock</b> function – Either soft lock (through the OSD menu) or hard lock (press and hold the button beside the power button for 6 seconds).
<b>Reset Menu</b>	Reset all OSD settings to the factory preset values.





## Personalize

Users can choose a feature from **Preset Modes**, **Brightness/Contrast**, **Auto Adjust**, **Input Source**, **Aspect Ratio**, or **Rotation** and set it as a shortcut key.

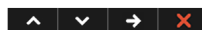
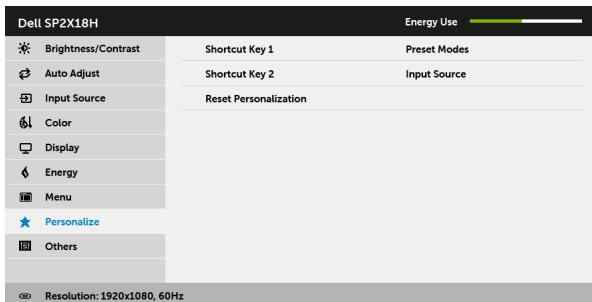

## Others

Select this option to adjust the OSD settings, such as the **DDC/CI**, **LCD Conditioning**, and so on.

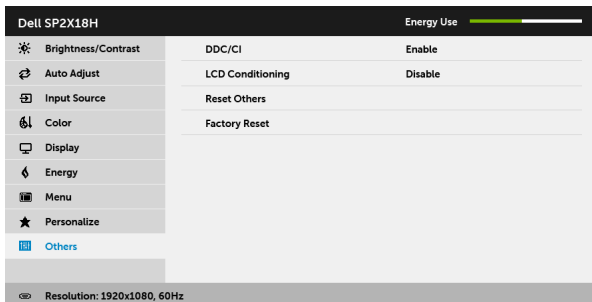

## DDC/CI

**DDC/CI** (Display Data Channel/Command Interface) allows your monitor parameters (brightness, color balance, and etc.) to be adjustable via the software on your computer. You can disable this feature by selecting **Disable**. Enable this feature for best user experience and optimum performance of your monitor.

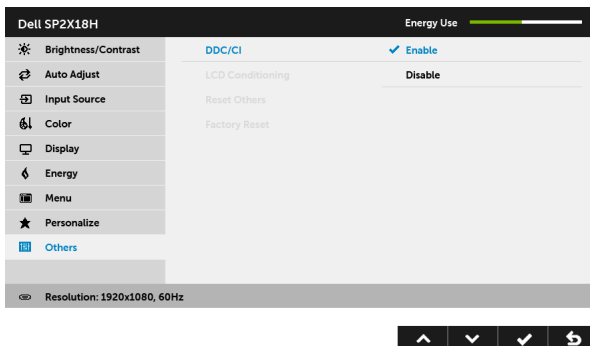

## LCD Conditioning

Helps reduce minor cases of image retention. Depending on the degree of image retention, the program may take some time to run. You can enable this feature by selecting **Enable**.

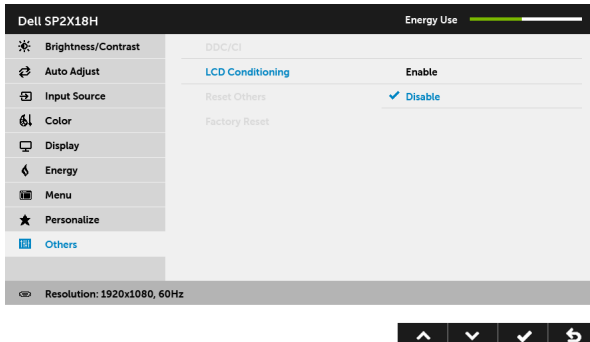



---

**Reset Others** Reset all settings under the **Others** menu to the factory preset values.

---

**Factory Reset** Reset all settings to the factory preset values.

---

 **NOTE: This monitor has a built-in feature to automatically calibrate the brightness to compensate for LED aging.**

### OSD Warning Message

When the **Dynamic Contrast** feature is enabled (in these preset modes: **Game** or **Movie**), manual brightness adjustment is disabled.

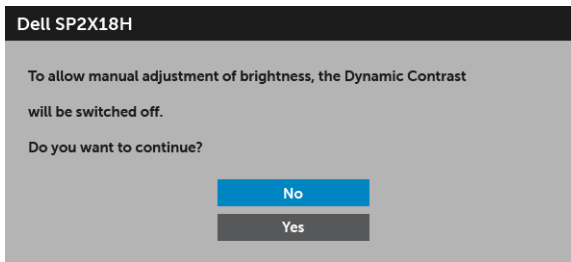

When the monitor does not support a particular resolution mode, you will see the following message:

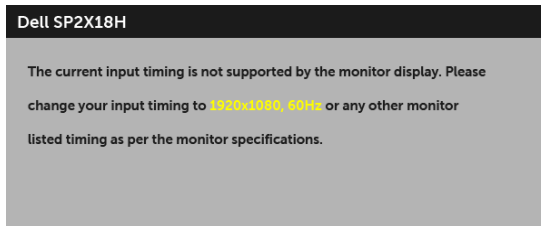

This means that the monitor cannot synchronize with the signal that it is receiving from the computer. See [Monitor Specifications](#) for the Horizontal and Vertical frequency ranges addressable by this monitor. Recommended mode is 1920 x 1080.



You will see the following message before the DDC/CI function is disabled:

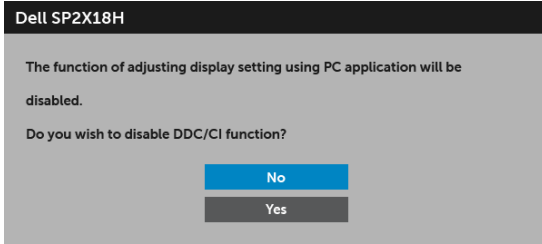

When the monitor goes into power-save mode, the following message appears:



Activate the computer and wake up the monitor to gain access to the **OSD**.

If you press any button other than the power button, the following message will appear depending on the selected input:

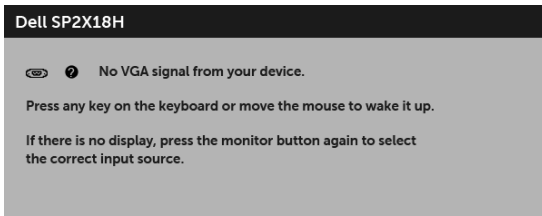

**NOTE:** The message may be slightly different according to the connected input signal.

If either VGA, HDMI, or DP input is selected and the corresponding cable is not connected, a floating dialog box as shown below appears.

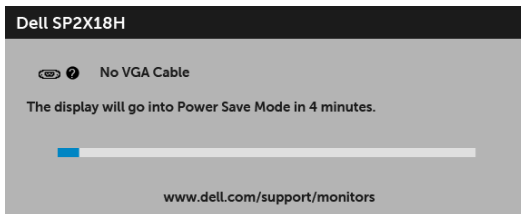

or



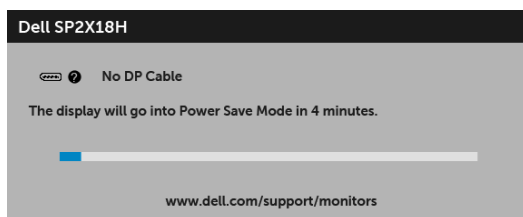

or

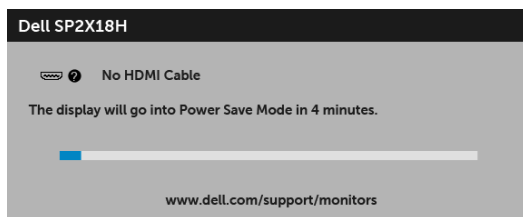

See [Troubleshooting](#) for more information.

## Setting the Maximum Resolution

To set the maximum resolution for the monitor:

In Windows<sup>®</sup> 7, Windows<sup>®</sup> 8, and Windows<sup>®</sup> 8.1:

1. For Windows<sup>®</sup> 8 and Windows<sup>®</sup> 8.1 only, select the Desktop tile to switch to classic desktop.
2. Right-click on the desktop and click **Screen Resolution**.
3. Click the Dropdown list of the Screen Resolution and select **1920 x 1080**.
4. Click **OK**.

In Windows<sup>®</sup> 10:

1. Right-click on the desktop and click **Display settings**.
2. Click **Advanced display settings**.
3. Click the dropdown list of **Resolution** and select **1920 x 1080**.
4. Click **Apply**.



If you do not see 1920 x 1080 as an option, you may need to update your graphics driver. Depending on your computer, complete one of the following procedures:

If you have a Dell desktop or portable computer:

- Go to <http://www.dell.com/support>, enter your service tag, and download the latest driver for your graphics card.

If you are using a non-Dell computer (portable or desktop):

- Go to the support site for your computer and download the latest graphic drivers.
- Go to your graphics card website and download the latest graphic drivers.

## Using the Tilt, Swivel, and Vertical Extension

**NOTE: This is applicable for a monitor with a stand. When any other stand is bought, please refer to the respective stand setup guide for set-up instructions.**

### Tilt, Swivel

With the stand attached to the monitor, you can tilt and swivel the monitor for the most comfortable viewing angle.

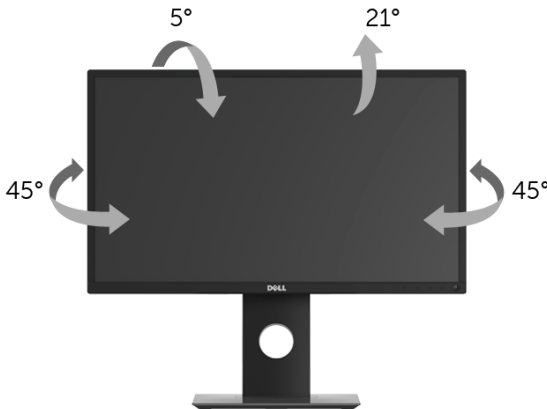

**NOTE: The stand is detached when the monitor is shipped from the factory.**



## Vertical Extension

 **NOTE:** The stand extends vertically up to 130 mm. The figure below illustrates how to extend the stand vertically.

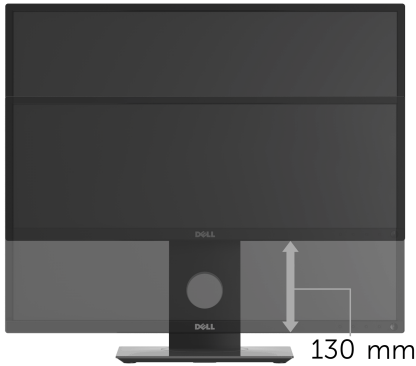

## Rotating the Monitor

Before you rotate the monitor, your monitor should be fully vertically extended ([Vertical Extension](#)) and fully tilted up to avoid hitting the bottom edge of the monitor.

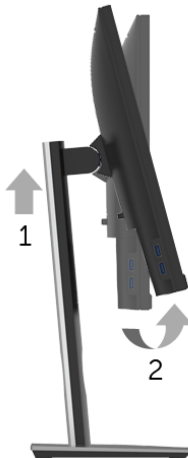



- NOTE:** To use the Display Rotation function (Landscape versus Portrait view) with your Dell computer, you require an updated graphics driver that is not included with this monitor. To download the graphics driver, go to [www.dell.com/support](http://www.dell.com/support) and see the Download section for Video Drivers for latest driver updates.
- NOTE:** When in the Portrait View Mode, you may experience performance degradation in graphic-intensive applications (3D Gaming and etc.).

## Adjusting the Rotation Display Settings of Your System

After you have rotated your monitor, you need to complete the procedure below to adjust the Rotation Display Settings of your system.

- NOTE:** If you are using the monitor with a non-Dell computer, you need to go the graphics driver website or your computer manufacturer website for information on rotating the 'contents' on your display.



To adjust the Rotation Display Settings:

1. Right-click on the desktop and click **Properties**.
2. Select the **Settings** tab and click **Advanced**.
3. If you have an ATI graphics card, select the **Rotation** tab and set the preferred rotation.
4. If you have an nVidia graphics card, click the **nVidia** tab, in the left-hand column select **NVRotate**, and then select the preferred rotation.
5. If you have an Intel® graphics card, select the **Intel** graphics tab, click **Graphic Properties**, select the **Rotation** tab, and then set the preferred rotation.

 **NOTE: If you do not see the rotation option or it is not working correctly, go to [www.dell.com/support](http://www.dell.com/support) and download the latest driver for your graphics card.**



# Troubleshooting

**⚠ WARNING:** Before you begin any of the procedures in this section, follow the [Safety Instructions](#).

## Self-Test

Your monitor provides a self-test feature that allows you to check whether your monitor is functioning properly. If your monitor and computer are properly connected but the monitor screen remains dark, run the monitor self-test by performing the following steps:

1. Turn off both your computer and the monitor.
2. Unplug the video cable from the back of the computer.
3. Turn on the monitor.

The floating dialog box should appear on-screen (against a black background), if the monitor cannot sense a video signal and is working correctly. While in self-test mode, the power LED remains white. Also, depending upon the selected input, one of the dialogs shown below will continuously scroll through the screen.

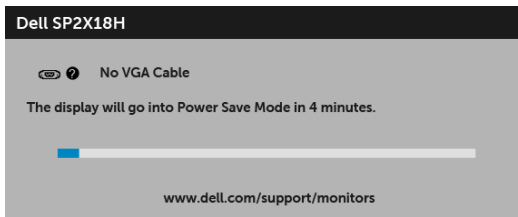

OR

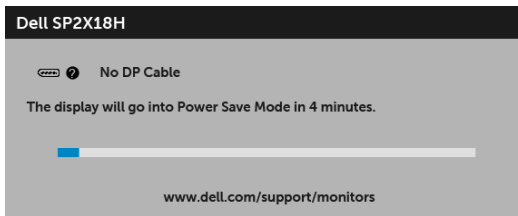

OR





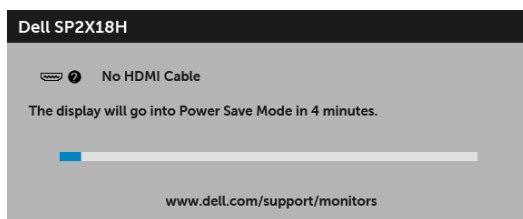

4. This box also appears during normal system operation, if the video cable becomes disconnected or damaged.
5. Turn Off your monitor and reconnect the video cable; then turn On both your computer and the monitor.

If your monitor screen remains blank after you use the previous procedure, check your video controller and computer, because your monitor is functioning properly.

## Built-in Diagnostics

Your monitor has a built-in diagnostic tool that helps you determine if the screen abnormality you are experiencing is an inherent problem with your monitor, or with your computer and video card.

 **NOTE: You can run the built-in diagnostics only when the video cable is unplugged and the monitor is in self-test mode.**

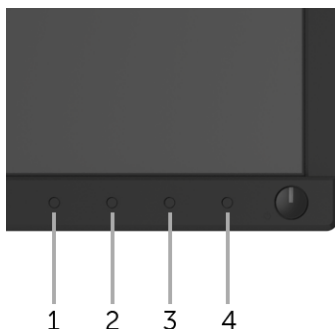

To run the built-in diagnostics:

1. Ensure that the screen is clean (no dust particles on the surface of the screen).
2. Unplug the video cable(s) from the back of the computer or monitor. The monitor then goes into the self-test mode.



3. Press and hold **Button 1** on the front panel for 5 seconds. A gray screen appears.
4. Carefully inspect the screen for abnormalities.
5. Press **Button 1** on the front panel again. The color of the screen changes to red.
6. Inspect the display for any abnormalities.
7. Repeat steps 5 and 6 to inspect the display in green, blue, black, white, and text screens.

The test is complete when the text screen appears. To exit, press **Button 1** again. If you do not detect any screen abnormalities upon using the built-in diagnostic tool, the monitor is functioning properly. Check the video card and computer.

## Common Problems

The following table contains general information about common monitor problems you might encounter and the possible solutions:

Common Symptoms	What You Experience	Possible Solutions
No Video/Power LED off	No picture	<ul style="list-style-type: none"> <li>• Ensure that the video cable connecting the monitor and the computer is properly connected and secure.</li> <li>• Verify that the power outlet is functioning properly using any other electrical equipment.</li> <li>• Ensure that the power button is pressed fully.</li> <li>• Ensure that the correct input source is selected in the <b>Input Source</b> menu.</li> </ul>



No Video/Power LED on	No picture or no brightness	<ul style="list-style-type: none"> <li>• Increase brightness &amp; contrast controls via OSD.</li> <li>• Perform monitor self-test feature check.</li> <li>• Check for bent or broken pins in the video cable connector.</li> <li>• Run the built-in diagnostics.</li> <li>• Ensure that the correct input source is selected in the <b>Input Source</b> menu.</li> </ul>
Poor Focus	Picture is fuzzy, blurry, or ghosting	<ul style="list-style-type: none"> <li>• Perform <b>Auto Adjust</b> via OSD.</li> <li>• Adjust the <b>Phase</b> and <b>Pixel Clock</b> controls via OSD.</li> <li>• Eliminate video extension cables.</li> <li>• Reset the monitor to factory settings.</li> <li>• Change the video resolution to the correct aspect ratio.</li> </ul>
Shaky/Jittery Video	Wavy picture or fine movement	<ul style="list-style-type: none"> <li>• Perform <b>Auto Adjust</b> via OSD.</li> <li>• Adjust the <b>Phase</b> and <b>Pixel Clock</b> controls via OSD.</li> <li>• Reset the monitor to factory settings.</li> <li>• Check environmental factors.</li> <li>• Relocate the monitor and test in another room.</li> </ul>
Missing Pixels	LCD screen has spots	<ul style="list-style-type: none"> <li>• Cycle power On-Off.</li> <li>• Pixel that is permanently Off is a natural defect that can occur in LCD technology.</li> <li>• For more information on Dell Monitor Quality and Pixel Policy, see Dell Support site at: <b><a href="http://www.dell.com/support/monitors">http://www.dell.com/support/monitors</a></b>.</li> </ul>



Stuck-on Pixels	LCD screen has bright spots	<ul style="list-style-type: none"> <li>• Cycle power On-Off.</li> <li>• Pixel that is permanently off is a natural defect that can occur in LCD technology.</li> <li>• For more information on Dell Monitor Quality and Pixel Policy, see Dell Support site at: <b>http://www.dell.com/support/monitors.</b></li> </ul>
Brightness Problems	Picture too dim or too bright	<ul style="list-style-type: none"> <li>• Reset the monitor to factory settings.</li> <li>• Perform <b>Auto Adjust</b> via OSD.</li> <li>• Adjust brightness &amp; contrast controls via OSD.</li> </ul>
Geometric Distortion	Screen not centered correctly	<ul style="list-style-type: none"> <li>• Reset the monitor to factory settings.</li> <li>• Perform <b>Auto Adjust</b> via OSD.</li> <li>• Adjust horizontal &amp; vertical controls via OSD.</li> </ul> <p><b>NOTE:</b> When using HDMI/DisplayPort input, the positioning adjustments are not available.</p>
Horizontal/Vertical Lines	Screen has one or more lines	<ul style="list-style-type: none"> <li>• Reset the monitor to factory settings.</li> <li>• Perform <b>Auto Adjust</b> via OSD.</li> <li>• Adjust the <b>Phase</b> and <b>Pixel Clock</b> controls via OSD.</li> <li>• Perform monitor self-test feature check and determine if these lines are also in self-test mode.</li> <li>• Check for bent or broken pins in the video cable connector.</li> <li>• Run the built-in diagnostics.</li> </ul> <p><b>NOTE:</b> When using HDMI/DisplayPort input, the <b>Pixel Clock</b> and <b>Phase</b> adjustments are not available.</p>



Synchronization Problems	Screen is scrambled or appears torn	<ul style="list-style-type: none"> <li>Reset the monitor to factory settings.</li> <li>Perform <b>Auto Adjust</b> via OSD.</li> <li>Adjust the <b>Phase</b> and <b>Pixel Clock</b> controls via OSD.</li> <li>Perform monitor self-test feature check to determine if the scrambled screen appears in self-test mode.</li> <li>Check for bent or broken pins in the video cable connector.</li> <li>Restart the computer in the <b>safe mode</b>.</li> </ul>
Safety Related Issues	Visible signs of smoke or sparks	<ul style="list-style-type: none"> <li>Do not perform any troubleshooting steps.</li> <li>Contact Dell immediately.</li> </ul>
Intermittent Problems	Monitor malfunctions on & off	<ul style="list-style-type: none"> <li>Ensure that the video cable connecting the monitor to the computer is connected properly and is secure.</li> <li>Reset the monitor to factory settings.</li> <li>Perform monitor self-test feature check to determine if the intermittent problem occurs in self-test mode.</li> </ul>
Missing Color	Picture missing color	<ul style="list-style-type: none"> <li>Perform monitor self-test feature check.</li> <li>Ensure that the video cable connecting the monitor to the computer is connected properly and is secure.</li> <li>Check for bent or broken pins in the video cable connector.</li> </ul>



Wrong Color	Picture color not good	<ul style="list-style-type: none"> <li>Change the settings of the <b>Preset Modes</b> in the <b>Color</b> menu OSD depending on the application.</li> <li>Adjust R/G/B value under <b>Custom Color</b> in <b>Color</b> menu OSD.</li> <li>Run the built-in diagnostics.</li> </ul>
Image retention from a static image left on the monitor for a long period of time	Faint shadow from the static image displayed appears on the screen	<ul style="list-style-type: none"> <li>Use the Power Management feature to turn off the monitor at all times when not in use (for more information, see <a href="#">Power Management Modes</a>).</li> <li>Alternatively, use a dynamically changing screensaver.</li> </ul>

## Product Specific Problems

Specific Symptoms	What You Experience	Possible Solutions
Screen image is too small	Image is centered on screen, but does not fill entire viewing area	<ul style="list-style-type: none"> <li>Check the <b>Aspect Ratio</b> setting in the <b>Display</b> menu OSD.</li> <li>Reset the monitor to factory settings.</li> </ul>
Cannot adjust the monitor with the buttons on the front panel	OSD does not appear on the screen	<ul style="list-style-type: none"> <li>Turn Off the monitor, unplug the power cord, plug it back, and then turn On the monitor.</li> <li>Check whether the OSD menu is locked. If yes, press and hold the button above the Power button for 6 seconds to unlock (for more information, see <a href="#">Lock</a>).</li> </ul>



No Input Signal when user controls are pressed	No picture, the LED light is white	<ul style="list-style-type: none"> <li>• Check the signal source. Ensure the computer is not in the power saving mode by moving the mouse or pressing any key on the keyboard.</li> <li>• Check whether the signal cable is plugged in properly. Re-plug the signal cable if necessary.</li> <li>• Reset the computer or video player.</li> </ul>
The picture does not fill the entire screen	The picture cannot fill the height or width of the screen	<ul style="list-style-type: none"> <li>• Due to different video formats (aspect ratio) of DVDs, the monitor may display in full screen.</li> <li>• Run the built-in diagnostics.</li> </ul>

 **NOTE: When choosing HDMI/DP mode, the Auto Adjust function will not be available.**

## Universal Serial Bus (USB) Specific Problems

Specific Symptoms	What You Experience	Possible Solutions
USB interface is not working	USB peripherals are not working	<ul style="list-style-type: none"> <li>• Check that your monitor is turned On.</li> <li>• Reconnect the upstream cable to your computer.</li> <li>• Reconnect the USB peripherals (downstream connector).</li> <li>• Switch Off and then turn On the monitor again.</li> <li>• Reboot the computer.</li> <li>• Some USB devices like external portable HDD require higher electric current; connect the device directly to the computer system.</li> </ul>



Super Speed USB 3.0 interface is slow	Super Speed USB 3.0 peripherals working slowly or not working at all	<ul style="list-style-type: none"> <li>• Check that your computer is USB 3.0-capable.</li> <li>• Some computers have USB 3.0, USB 2.0, and USB 1.1 ports. Ensure that the correct USB port is used.</li> <li>• Reconnect the upstream cable to your computer.</li> <li>• Reconnect the USB peripherals (downstream connector).</li> <li>• Reboot the computer.</li> </ul>
Wireless USB peripherals stop working when a USB 3.0 device is plugged in	Wireless USB peripherals responding slowly or only working as the distance between itself and its receiver decreases	<ul style="list-style-type: none"> <li>• Increase the distance between the USB 3.0 peripherals and the wireless USB receiver.</li> <li>• Position your wireless USB receiver as close as possible to the wireless USB peripherals.</li> <li>• Use a USB-extender cable to position the wireless USB receiver as far away as possible from the USB 3.0 port.</li> </ul>





# Appendix

## **WARNING: Safety Instructions**

 **WARNING: Use of controls, adjustments, or procedures other than those specified in this documentation may result in exposure to shock, electrical hazards, and/or mechanical hazards.**

For information on safety instructions, see the Safety, Environmental, and Regulatory Information (SERI).

## **FCC Notices (U.S. Only) and Other Regulatory Information**

For FCC notices and other regulatory information, see the regulatory compliance website located at [www.dell.com/regulatory\\_compliance](http://www.dell.com/regulatory_compliance).

## **Contact Dell**

**For customers in the United States, call 800-WWW-DELL (800-999-3355).**

 **NOTE: If you do not have an active Internet connection, you can find contact information on your purchase invoice, packing slip, bill, or Dell product catalog.**

**Dell provides several online and telephone-based support and service options. Availability varies by country and product, and some services may not be available in your area.**

- Online technical assistance — [www.dell.com/support/monitors](http://www.dell.com/support/monitors)
- Contacting Dell — [www.dell.com/contactdell](http://www.dell.com/contactdell)

